



Bedienungsanleitung



Torq Abfallbehälter Elevation

Art.Nr.: 28553

▶▶▶ [zum Produkt ...](#)

Seife & Spender

▶▶▶ [zur Kategorie...](#)

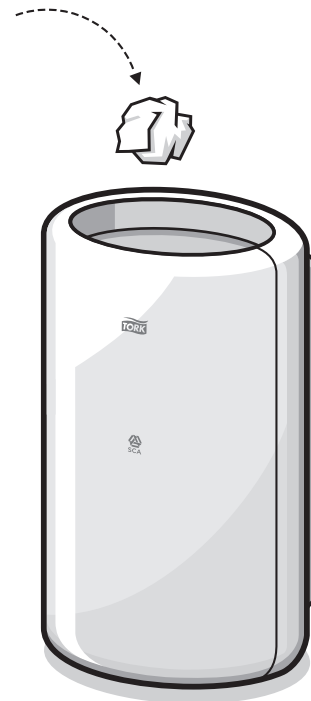

Elevation
Design

A vertical grey bar with the text 'Elevation Design' in white, positioned to the right of the product information card.

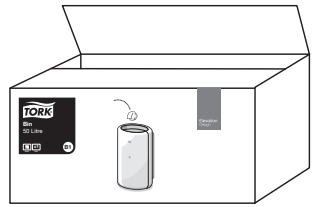

+

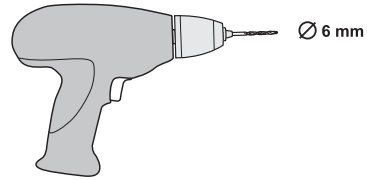
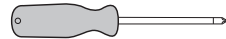

Ø 6 mm

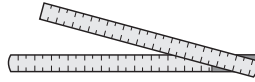

x 4

x 4

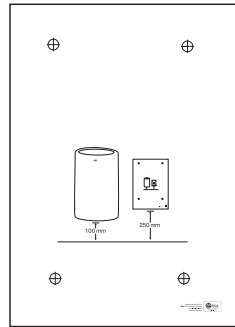
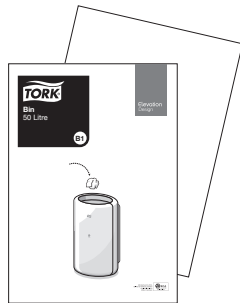

A

B

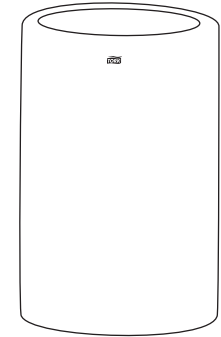
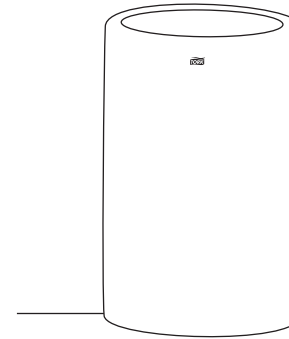

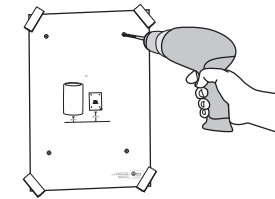
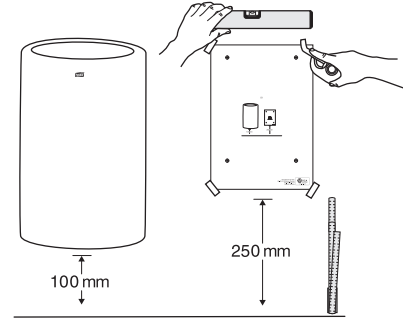

1.

2.



3.

-  x 4
-  x 4

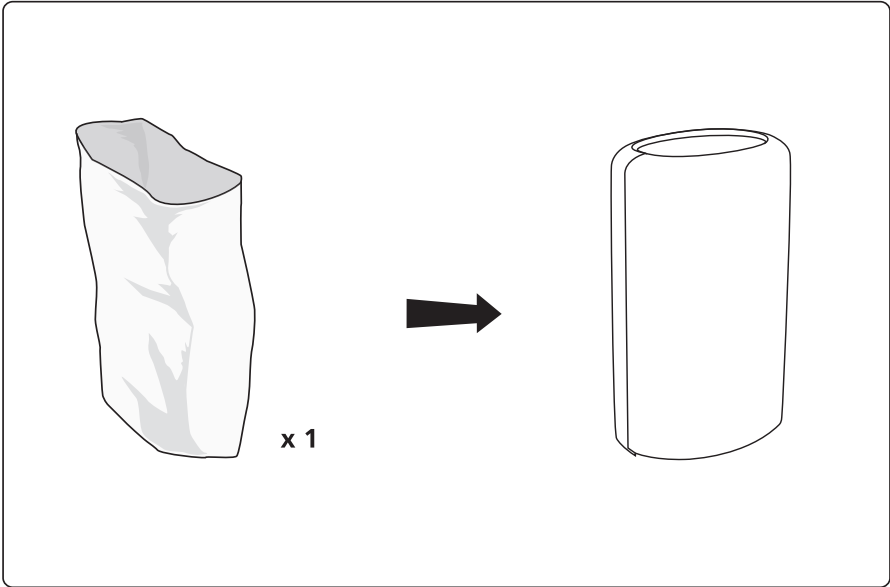
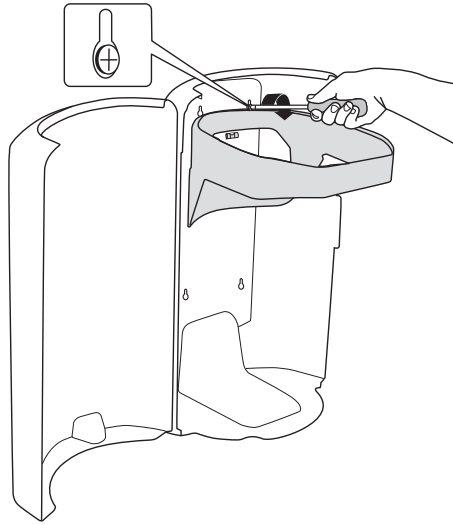

4.

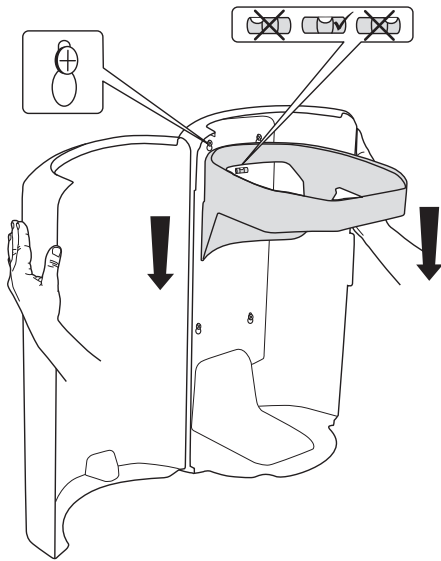

1.

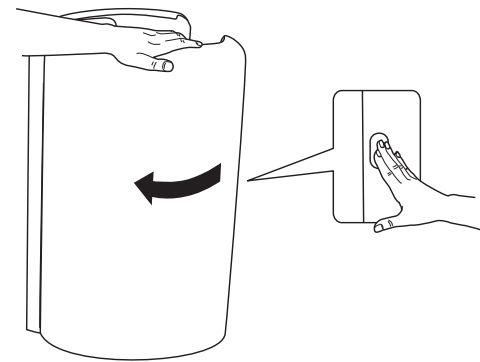

2.

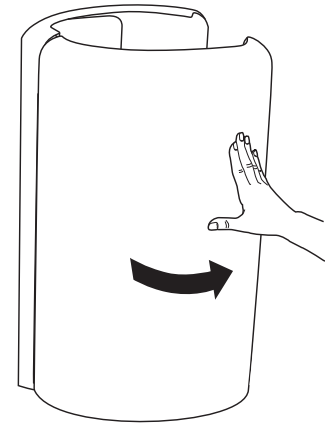
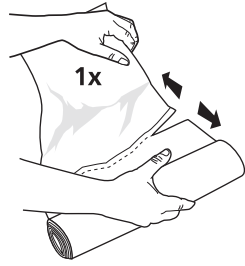

3.

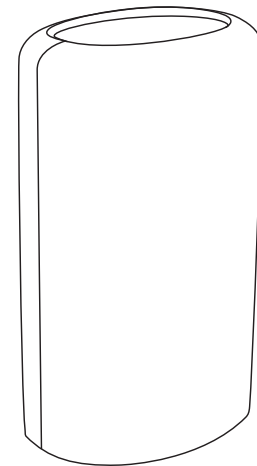

4.

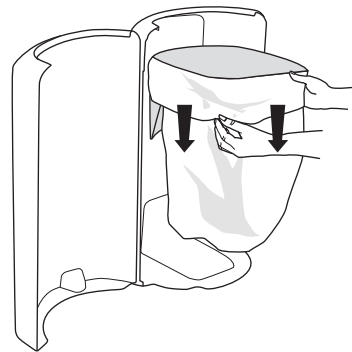



Sport-Tec
Physio & Fitness

Lemberger Straße 255
D-66955 Pirmasens

Tel.: 06331/1480-0
Fax: 06331/1480-220

info@sport-tec.de
www.sport-tec.de